

107415023 A



INSTRUCTIONS FOR USE

TRIUMPH 12S - 86064



Contents

1	Important safety instructions.....	03
1.1	<i>Symbols used to mark instructions</i>	03
1.2	<i>Warnings.....</i>	03
1.3	<i>Grounding instructions.....</i>	04
2	Introduction	05
2.1	<i>Operating elements and accessories</i>	05
2.2	<i>Instructions for use</i>	06
2.3	<i>Purpose and intended use.....</i>	06
2.4	<i>Further support</i>	06
2.5	<i>Before use</i>	06
3	Before starting the cleaner.....	07
3.1	<i>Setting up the cleaner.....</i>	07
4	Control / Operation.....	08
4.1	<i>Operating the vacuum cleaner</i>	08
4.2	<i>Clearing a clog</i>	09
4.3	<i>Using the wand (optional)</i>	10
4.4	<i>Using the tools (optional).....</i>	11
5	Maintenance.....	12
5.1	<i>Changing the paper dust bag</i>	12
5.2	<i>Emptying the cloth dust bag</i>	14
5.3	<i>Changing or cleaning of the brush.....</i>	14
5.4	<i>Filters - type of filter may vary from different models.....</i>	15
5.5	<i>Changing the HEPA-filter.....</i>	16
5.6	<i>Cleaning or changing</i>	17
	<i>the pre-filter.....</i>	17
6	After using the cleaner	18
6.1	<i>Switching off the cleaner.....</i>	18
7	Further information	19
7.1	<i>Repair and maintenance.....</i>	19
7.2	<i>Guarantee.....</i>	19
7.3	<i>Specifications.....</i>	19
7.4	<i>Parts list.....</i>	20

1 Important safety instructions

1.1 Symbols used to mark instructions

DANGER



- Danger that leads directly to serious or irreversible injuries, or even death.

WARNING



- Danger that can lead to serious injuries or even death.

CAUTION



- Danger that can lead to minor injuries and damage.

1.2 Warnings



WARNING

- To reduce the risk of fire, electric shock, or injury. Do not leave the appliance when it is plugged in. Unplug the unit from the outlet when not in use and before servicing.
- To reduce the risk of electric shock, do not use outdoors or on wet surfaces.
- Do not allow to be used as a toy. Close attention is necessary when used by or near children.
- Use only as described in this manual. Use only the manufacturer's recommended attachments.
- If the appliance is not working as it should be, has been dropped, damaged, left outdoors or dropped into water, return it to a service center. The machine must not be used if the electrical cord shows any sign of damage. Regularly inspect the cord for damage, particularly if it has been crushed, shut in a door or run over.
- Do not pull or carry by the cord, use the cord as a handle, or pull the cord around sharp edges or corners. Keep the cord away from heated surfaces.
- Do not unplug by pulling on the cord. To unplug, grasp the plug, not the cord.
- Do not handle the plug, cord or appliance with wet hands.
- Do not put any object into openings. Do not use with any opening blocked.
- Keep loose clothing, hair, fingers, and all parts of body away from openings and moving parts.
- Do not pick up anything that is burning or smoking, such as cigarettes or matches. Under no circumstances should the machine be used for picking up hot material. In particular the machine must not be used for cleaning open and closed fireplaces, ovens or similar that contain warm or glowing ashes.
- Do not use without dust bag and/or filters in place.
- Turn off all controls before unplugging. The plug must always be removed from the socket outlet before starting any service or repair work of the vacuum cleaner or the cord.
- Avoid vacuuming hard or sharp objects.
- Use extra care when cleaning on stairs.
- The machine must not be used for picking up combustible materials which are health endangering or explosive materials such as petrol (gasoline), nor should it be used in an explosive atmosphere. The machine must not be used for picking up water, other liquids or for picking up hazardous - i.e. poisonous dust.
- The machine is not designed for picking up hazardous - i.e. poisonous dust.
- This machine is for dry use only.



WARNING

- No changes or modifications of the mechanical, electrical or thermal safety devices should be made.
- When repairing or replacing the cord, the same type of cord as originally supplied with the machine must be used.
- Do not allow the supply cord to come into contact with the rotating brushes..

SAVE THESE INSTRUCTIONS

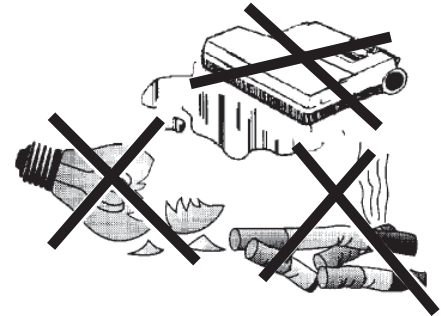

1.3 Grounding instructions

This appliance must be grounded. If it should electrically malfunction, grounding provides a path of least resistance for electric current to reduce the risk of electric shock. This appliance is equipped with a cord having an equipment-grounding conductor and grounding plug. The plug must be plugged into an appropriate outlet that is properly installed and grounded in accordance with all local codes and ordinances.



DANGER

Improper connection of the equipment-grounding conductor can result in a risk of electric shock. Check with a qualified electrician or service person if you are in doubt as to whether the outlet is properly grounded. Do not modify the plug provided with the appliance. If it will not fit the outlet, have a proper outlet installed by a qualified electrician.

This appliance is for use on a nominal 120-volt circuit, and has a grounding plug that looks like the plug illustrated in Figure 1 below. A temporary adapter illustrated in Figures 2 and 3 may be used to connect this plug to a 2-pole receptacle as shown in Figure 2 if a properly grounded outlet is not available. The temporary adapter should be used only until a properly grounded outlet (Figure 1) can be installed by a qualified electrician.

The green-colored rigid ear, tab, or the like extending from the adapter must be connected to a permanent ground such as a properly grounded outlet box cover. Whenever the adapter is used, it must be held in place by a metal screw. Grounding adapters are not approved for use in Canada.

Replace the plug if the grounding pin is damaged or broken.

The Green (or Green/Yellow) wire in the cord is the grounding wire. When replacing a plug, this wire must be attached to the grounding pin only.

Extension cords connected to this machine should be 12 gauge, three-wire cords with three-prong plugs and outlets.

DO NOT use extension cords more than 50 feet (15 meter) long.

PLEASE NOTE: FOR NORTH AMERICA ONLY

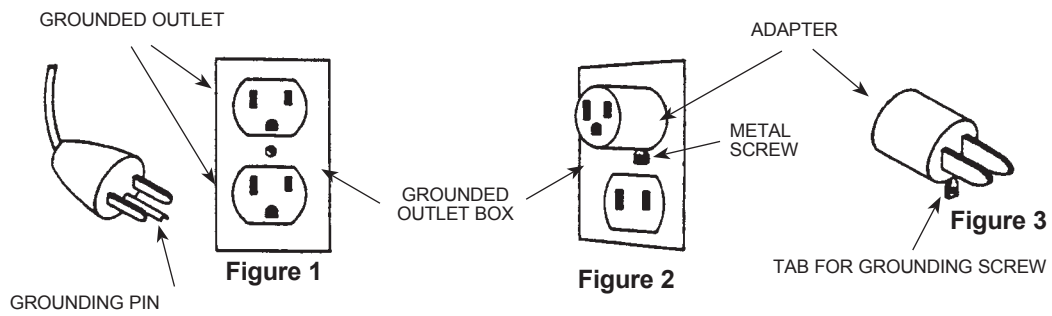

2 Introduction

2.1 Operating elements and accessories

As you read this manual, you will occasionally run across a bold number in parentheses - example: (2). These numbers refer to an item shown on this page. Refer back to this page whenever necessary, to pinpoint the location of an item mentioned in the text.

- | | |
|--------------------|--------------------------------|
| 1. Handle | 8. Wand |
| 2. Cord Hook | 9. Crevice Tool |
| 3. Vacuum Hose | 10. "Restricted Airflow Light" |
| 4. Dust lid | 11. Dust lid button |
| 5. Carrying Handle | 12. Main Power Switch |
| 6. Brush Housing | 13. Exhaust Filter Cover |
| 7. Pedal | 14. Power Cord Clamp |

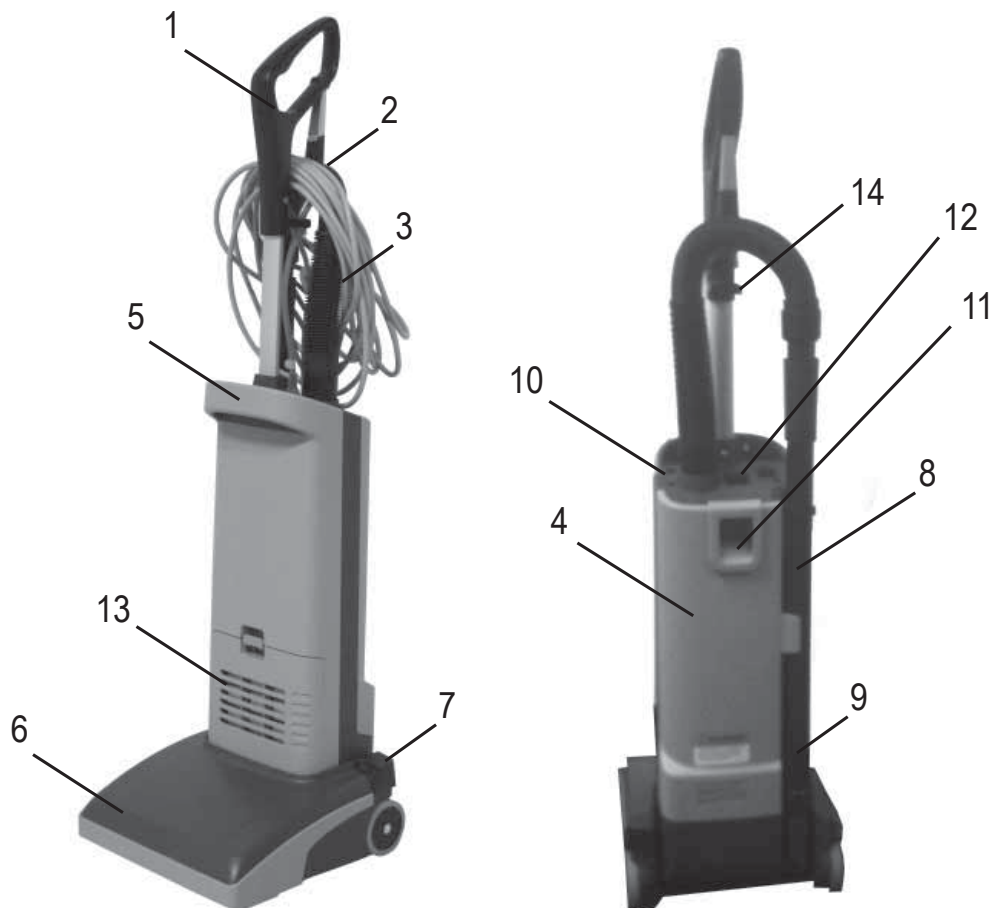

2.2 Instructions for use



This manual will help you get the most from your vacuum cleaner.

Prior to using the appliance for the first time, be sure to read this document through and keep it ready to hand.

Besides the operating instructions and the binding accident prevention regulations valid in the country of use, observe recognised regulations for safety and proper use.

RATING PLATE

The Model Number and Serial Number of your machine are shown on the rating plate on the machine.

This information is needed when ordering spare parts for the machine. Use the space below to note the Model Number and Serial Number of your machine for future reference.

MODEL NUMBER _____

SERIAL NUMBER _____

2.3 Purpose and intended use

This machine is for commercial use, for example in hotels, schools, hospitals, factories, shops and offices other than normal residential housekeeping purposes.

Any other use is considered as improper use. The manufacturer accepts no liability for any damage resulting from such use. The risk for such use is borne solely by the user. Proper use also includes proper operation, servicing and repairs as specified by the manufacturer.

**THIS APPLIANCE IS INTENDED FOR DRY USE ONLY!
DO NOT USE FOR WET FLOOR OR CARPET!**

2.4 Further support

For further queries, contact the place of purchase or an authorized service center.

2.5 Before use

Before starting up your machine, please check it carefully for any defects. If you find any, do not start up your machine.

- When the machine is delivered, carefully inspect the shipping carton and the machine for damage.
- If damage is evident, save the shipping carton so that it can be inspected.
Contact the place of purchase immediately to file a freight damage claim.

3 Before starting the cleaner

3.1 Setting up the cleaner



1. Carefully take out the vacuum cleaner from its carton.
2. Insert the handle at the opening at the top of the bag housing. Push the button to secure the handle in place.
3. Mount the plug into the machine socket.



4. Mount the wand and hose as shown.



CAUTION

- Foot pedal must be used to release base to operating/non operation position. Failure to do so could result in damage to the release mechanism.

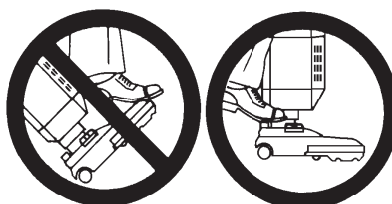

4 Control / Operation

4.1 Operating the vacuum cleaner



1. Engage the carabine function to release the cord.
2. Ensure the cord is looped and locked in the restraint clip.
3. Turn the Main Power Switch (12) ON. "I" is ON and "O" is OFF. Now the vacuum motor will start.
4. Step on the Pedal (7) and then tilt the cleaner backwards. The brush is always turning when on.

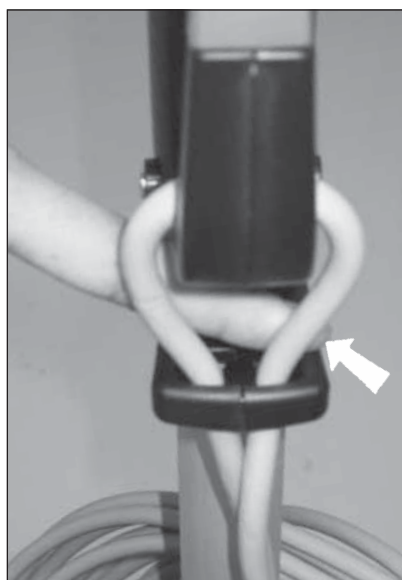



CAUTION

- Foot pedal must be used to release base to operating/non operation position. Failure to do so could result in damage to the release mechanism.

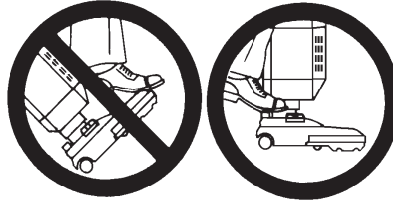

WARNING

- Always disconnect the power cord before performing any machine maintenance.

Whenever (10) “Restricted Airflow Light” indicator comes on, check the following: Is the bag full and needs to be changed or is the tube, hose or nozzle blocked.

For details of dust bag replacement see separate instruction in this manual. If the light comes on before the bag is full, the inside of the bag may be coated with very fine dust (change the bag), or debris may have clogged the hose between the brush and the bag.

4.2 Clearing a clog

First remove the upper hose and wand, and inspect them for clogged debris. Then detach the wand receptacle by pulling at it. It will lay flat on the floor, connected to the base hose.

Release and remove the brush cover and brush as described on page 14. Now inspect the lower hose, looking through it from the wand receptacle to the brush housing area. You should be able to see clear through it. If you can't there is probably debris clogged in it. You may remove the debris by pushing it forward to the brush opening with a long narrow object, such as a ruler or screw driver. Pull the debris out from the brush housing opening until you can see clearly through the hose.

Once the clog is cleared, replace the brush and brush cover. Then re-attach the wand receptacle, which clicks into place.

4.3 Using the wand (optional)



1. Push the machine to upright locked position. The brush will be lifted up from the surface. Then slide the wand out of its holder.



2. Use the wand for cleaning hard to reach places like floor corners, or furniture.



CAUTION

- Foot pedal must be used to release base to operating/non operation position. Failure to do so could result in damage to the release mechanism.



4.4 Using the tools (optional)



1. The crevice tool is placed in the lower section of the cleaner.
2. Install the Crevice Tool or Upholstery Tool on the end of the Wand, or on the end of the hose, which can be detached from the wand, if desired. Now the vacuum cleaner will have an extended coverage performance and can be used for cleaning hard to reach areas like roof strips, or furnitures.

These tools are not standard items in all machine variants. Use these tools for a better cleaning performance at hard to reach areas. A Crevice Tool (9) is placed conveniently on the machine, just behind the wand.

Remove the wand from the vacuum cleaner and you will have free access to the Tools.



CAUTION

- Foot pedal must be used to release base to operating/non operation position. Failure to do so could result in damage to the release mechanism.

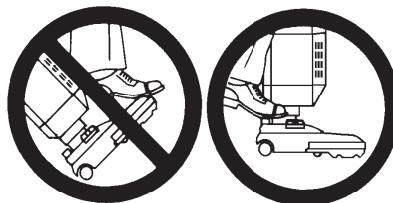

5 Maintenance



WARNING

- Always disconnect the power cord before performing any machine maintenance.

5.1 Changing the paper dust bag

Change the bag whenever the “Bag Full” (10) indicator comes on. To replace the Paper Dust Bag:



1. Disconnect the power cord from the electrical outlet. Pull the Dust lid button (11).



2. Remove the Dust lid outwards to remove it from the cleaner.

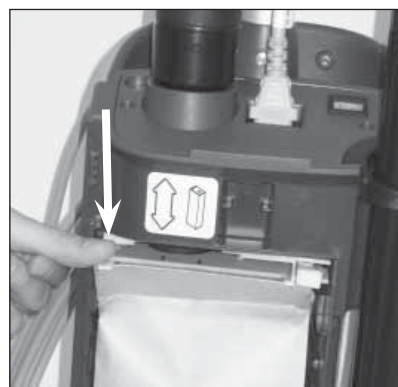

3. Push downwards at the edge to the left of the plastic holder, so that the bag loosens from the vacuum inlet of the machine.



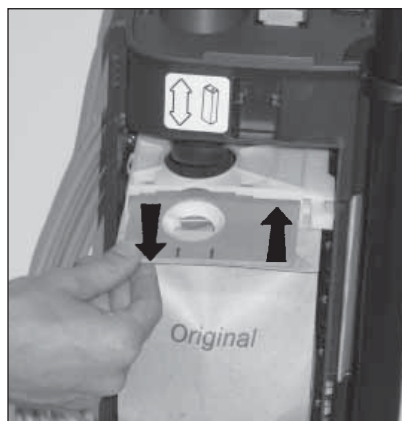

4. Grasp at the cardboard piece of the bag and gently pull the full bag outwards - away from cleaner.

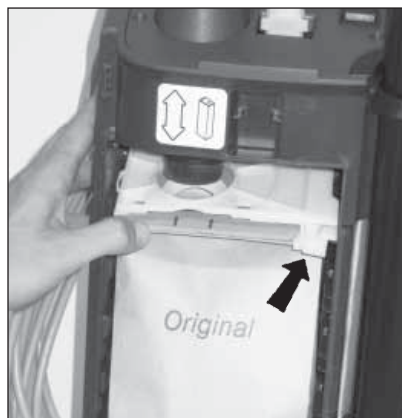

5. Insert a new paper dust bag into the slot of the bag holder and push the bag in place. Check so that the paper dust bag not is jammed in the holder. Only the cardboard piece of the bag should be attached to the bag holder.

6. Push the bag holder with the new bag upwards, so that the bag inlet fastens to the inlet of the machine. Make sure that the bag is unfolded and will fit in place in the bag housing. Also check that the "no bag" clip is placed to the left so that the lid will be able to close.



7. Fit the two notches of the back cover to the two slots at the lower part of the bag housing, and push the back cover back in place at the housing.

5.2 Emptying the cloth dust bag

Empty the Bag whenever the "Bag Full" Light (10) comes on. To empty or to replace:

1. Remove cloth bag as above in steps 1-3.
Disconnect the power cord from the electrical outlet. Pull the Dust lid button (11) and remove the Dust lid outwards to remove it from the cleaner.
2. Push downwards at the edge to the left of the plastic holder, so that the bag loosens from the vacuum inlet of the machine.
3. Grasp at the plastic flange of the bag and gently pull the bag outwards - away from cleaner.
4. Remove bag clip and shake out bag contents.
5. Put the bag clip back on the bag.
6. Replace clean/new cloth bag into machine and close back cover as above in step 4-6. Insert the cleaned/new cloth bag into the slot of the bagholder and push the bag in place so that bag is secured.
7. Push the bag holder with the new bag upwards, so that the bag inlet fasten to the inlet of the machine. Make sure that the bag is unfold and will fit in place at the bag housing. Also check that the "no bag" clip is placed to the left so that the lid will be able to close.
8. Fit the two notches of the back cover to the two slots at the lower part of the bag housing, and push the back cover back in place at the housing.



CAUTION

- Photos shows changing of the paper dust bags!
Never operate the machine without a Dust Bag in place.

5.3 Changing or cleaning of the brush



WARNING

- Always disconnect the power cord before performing any machine maintenance.

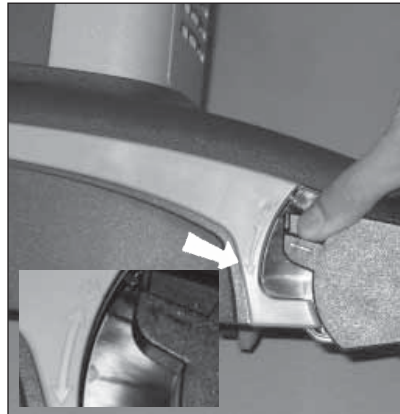

1. Unplug the power cord from the electrical outlet.
2. Release the brush roller by unlocking the bearing block. Push the button down towards the unlocking symbol at the brush housing.



3. Grasp at the bearing block and pull it out from the brush housing.



4. Remove the used brush.
5. Replace the used brush roller with a new one, or clean and remove all debris from the present brush.



6. Slide back the brush into the the fixed bearing block in the brush house.

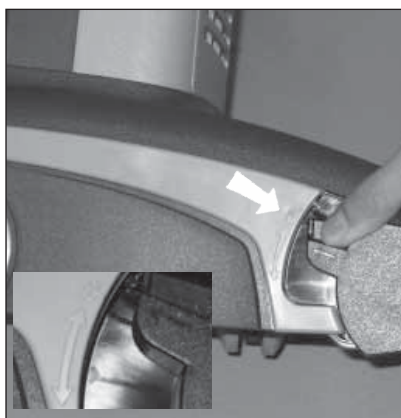

7. Push the bearing block in its position. Lock it by turning clockwise.

5.4 Filters - type of filter may vary from different models

On these machines there are two different filters; one pre-filter before the vacuum motor and one exhaust filter.

There are two different types of exhaust filters available to these machines, HEPA-filter and a standard exhaust filter. The HEPA-filter (High Efficiency Particulate Air filter) offers better filtration capacity than the standard exhaust filter. The exhaust filters catches any dirt that may escape from the dust bag, or motor pre filter. Replace the motor pre filter every 5th time that the dust bag is changed (more often in very dusty applications). The exhaust filters are located at the front side of the machine just above the brush base.

The HEPA filter can not be cleaned or washed clean. When the HEPA-filter is clogged it must be replaced. Replace the exhaust / HEPA filter 1-2 times per year depending on amount of use.

5.5 Changing the HEPA-filter



1. Disconnect the power cord from the electrical outlet. Push the Filter Cover Latch (13) downwards so that the cover is released. Remove the filter cover from cleaner.



2. Grasp at the filter frame and remove the used and dirty HEPA-filter.

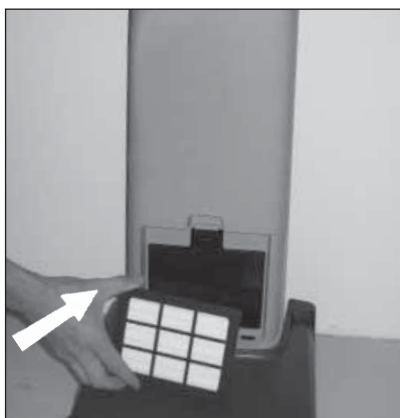

3. Grasp at the filter frame and then insert the new HEPA filter to the cleaner by pushing it in place. (Never touch the filter media of a HEPA-filter! Doing so may cause a loss of performance of the HEPA-filter).



4. Snap the Filter Cover back in place at the cleaner.



CAUTION

- Never operate the cleaner without the HEPA-Filter in place in the machine. These machines are not designed for picking up hazardous - i.e. poisonous dust!

5.6 Cleaning or changing the pre-filter

The pre filter catches any dirt spilled from the bag, before it can enter the vacuum motor. The filter is located below the bag. Clean or replace motor pre filter every 5th time that the bag is changed. (more often in very dusty applications).



1. Disconnect the power cord from the electrical outlet. Then push the Dust lid button (11) in and remove the dust lid (4).



2. Grasp at the filter holder and pull the holder out from the Dust compartment.

3. Remove the dirty filter from the filter holder and replace with a new pre filter. The pre filter may also be washed. Wash it in warm water. Let the filter dry completely before putting it back into the filter holder.



4. This machine is also equipped with a deodorizer pad. It's located in the pre filter holder. Replace it to a new deodorizer pad when the function begins to fade.

5. Put back the new/washed filter into the holder. Then put back the holder with filter in place in the bag housing.



6. Fit the two notches of the back cover to the two slots at the lower part of the bag housing, and push the back cover back in place at the housing.



WARNING

- Never operate the machine without the pre-filter in place.

6 After using the cleaner

6.1 Switching off the cleaner



1. Unplug the Power Cord from the electrical outlet.
2. If the machine is not cleaning as expected and the "Restricted Airflow light" is not illuminated, open the dust housing to ensure that the dust bag is not full, replace it if necessary. See also separate instructions for replacing the dust bag. Clean the bag housing if necessary.
3. Wind up the cord (starting from the machine inlet side).
4. Store the cord on the hook at the Dust lid cover and the hook at the handle.
5. Check the brush house. Remove any built-up carpet fibers or debris from the brush and the brush housing.
6. Store the machine indoors in a clean, dry place.

7 Further information

7.1 Repair and maintenance

Repairs, when required, should be performed by your Authorized Service Center, who employs factory trained service personnel, and maintains an inventory of original replacement parts and accessories. Call the DEALER named below for repair parts or service. Please specify the Model and Serial Number when discussing your machine.
(Dealer, affix service sticker here.)



WARNING

- Always remove the electric plug from the socket before carrying out maintenance work on the machine.

7.2 Guarantee

Our general conditions of business are applicable with regard to the guarantee.

Unauthorised modifications to the appliance, the use of incorrect accessories, spare parts and cleaning chemicals in addition to using the appliance in a way other than for the intended purpose exempt the manufacturer from any liability for the resulting damage.

7.3 Specifications

Triumph 12S		
Voltage	V/Hz	110-120/50-60
Rated Power	W	1000
Protection class (electrical)		I
Sound Pressure Level	dB(A)	69
Total weight both	lbs/Kg	19,5/8,9
Total weight without cord	lbs/Kg	17,6/8,0

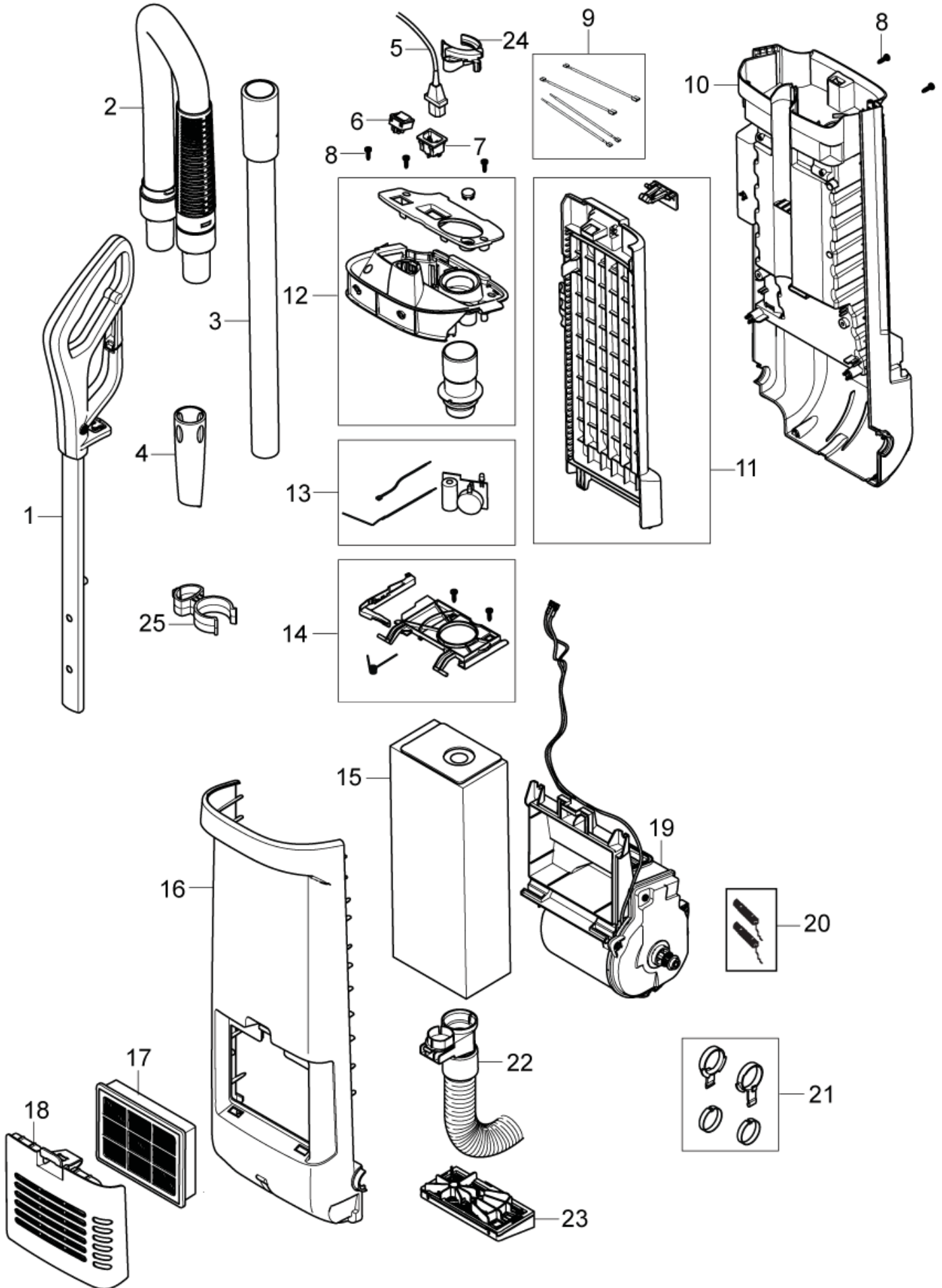

Model: Triumph 12S
Drawing: Triumph 12S-2 Body

IA	Pos. no.	Qty.	Item no.	Item Text
	01	1	107407581	HANDLE CPL
	02	1	147 0950 500	HOSE STRETCHABLE
	03	1	147 0851 500	EXTENSION TUBE 35MM
	04	1	147 1203 500	CREVICE NOZZLE 35
	05	1	107407582	DATAACHABLE CORD SET
	05	1	107407713	DETACHABLE CORD 50FT
	06	1	140 5496 510	SWITCH UL KIT
	07	1	107407583	APPLIANCE INLET
	08	1	140 9214 040	SCREW PTK TORX 40X14 MM FZB
	09	1	107407590	WIRE SET
	10	1	107407584	BODY COVER REAR
	11	1	107407585	LID CPL.
	12	1	107407586	COVER TOP CPL
	13	1	147 0987 500	BAG FULL DEVICE
	14	1	147 0854 500	HOLDER DUST BAG KIT
	15	1	107407587	DUST BAG
	16	1	107407588	COVER BODY FRONT
	17	1	147 1250 600	HEPA-FILTER. H13
	18	1	107407589	COVER EXHAUST FILTER
	19	1	147 0864 510	MOTOR CASSETTE 110-120V
	20	1	147 1326 500	CARBON BRUSH KIT
	21	1	147 0927 500	JOINT BASE TO BODY W RING
	22	1	147 0919 500	ADAPTER BASE TO TUBE W.HOSE
	23	1	147 0958 500	HOLDER PRE FILTER KIT
	24	1	107407717	TUBE HOLDER
	25	1	107407699	ACCESSORY HOLDER

Model: Triumph 12S
Drawing: Triumph 12S-3 Base 12"

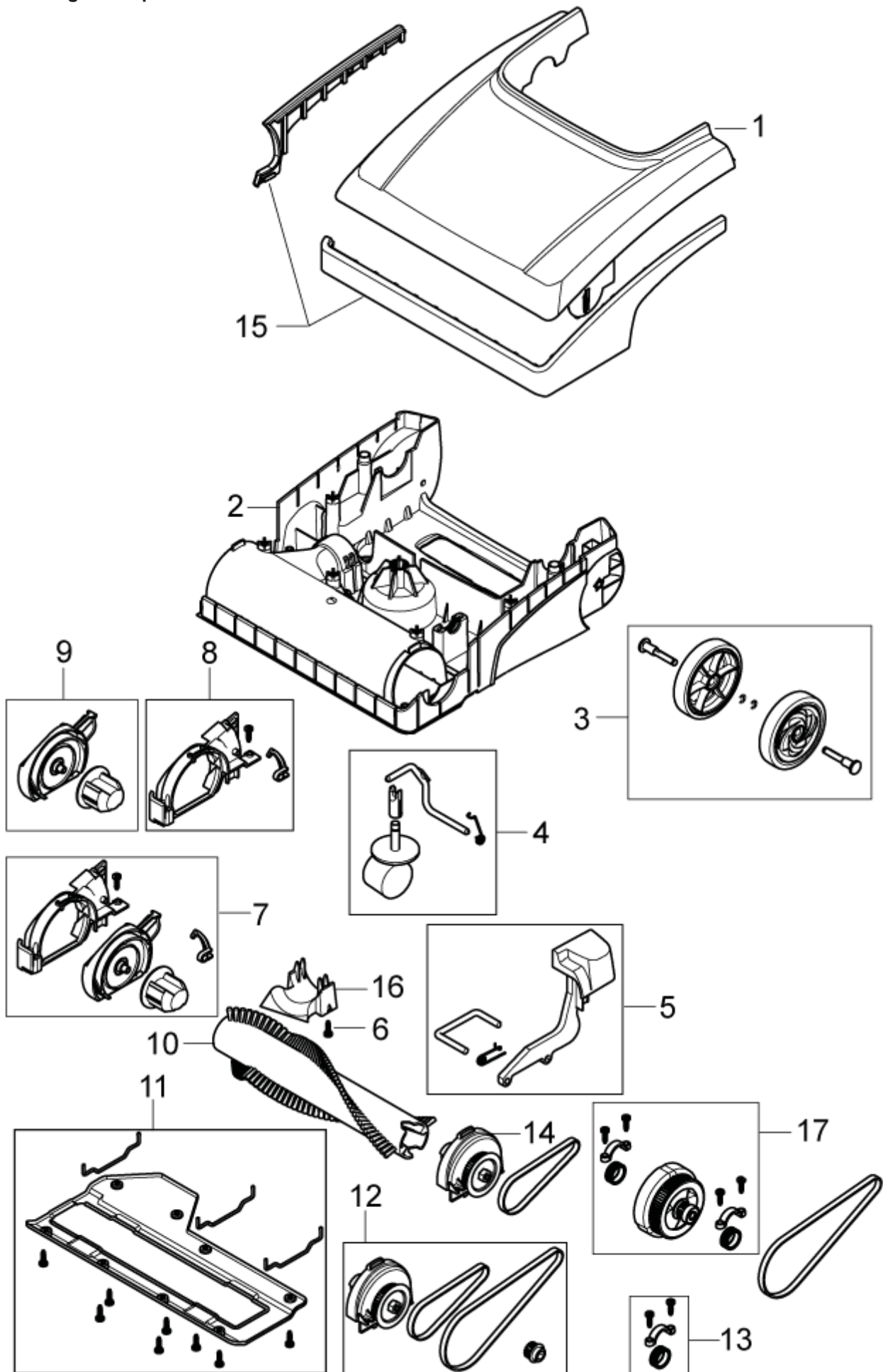

Model: Triumph 12S
Drawing: Triumph 12S-4 Base 12"

IA	Pos. no.	Qty.	Item no.	Item Text
	01	1	107407569	COVER BASE
	02	1	107407571	CHASSIS 12INCH
	03	1	147 0898 500	WHEEL KIT
	04	1	107407573	CASTOR KIT
	05	1	107407574	PEDAL WITH SHAFT AND SPRING
	06	1	140 9214 040	SCREW PTK TORX 40X14 MM FZB
	07	1	107407575	BRUSH COVER AND FRAME CPL
	08	1	107407576	BRUSH FRAME WITH CLIP
	09	1	107407577	BRUSH COVER WITH BEARING
	10	1	107407697	BRUSH 12INCH RED
	11	1	107407578	BRUSH SHOE 12INCH 305
	12	1	107407698	BLOCK W. BELT AND DRIVE PULLEY
	13	1	107407580	CLAMP AND GASKET KIT
	14	1	147 0913 500	END CAP BRUSCH LEFT W BEARING
	15	1	107407718	BUMPER 12INCH
	16	1	107407723	LOWER HOSE CLAMP
	17	1	107407722	END CAP BRUSH LEFT W BEARING



WARRANTY POLICY

The warranty terms outlined below are in lieu of any other warranties, either stated or implied, including any implied warranty of merchantability, fitness for a particular purpose or otherwise. Under no circumstances will seller be liable for any loss, damage, expense or consequential damages arising in connection with the use or inability to use this product.

This warranty does not apply to damage or defect caused by accident, misuse, negligence, abuse, fire or to any Triple S product which has been serviced by anyone other than a Triple S authorized service representative. Housings or parts that have become damaged as a result of improper use of the machine are excluded from this warranty. Refer to owner's manual for proper machine use and maintenance. Parts that are expected to wear from normal use and, therefore are not covered under the parts warranty include, but are not limited to: batteries (pro-rated for one year); bearings; belts; brushes; filters; squeegees; switches; and tires.

This warranty commences on the date of purchase of the product by the original end user from an authorized Triple S distributor, subject to proof of purchase. If proof of purchase date is unavailable, the warranty begins 90 days after the sale of the product to an authorized Triple S distributor.

- Subject to the conditions outlined above, the manufacturer warrants the rotationally-molded polyethylene housings and parts on its machines to be free from defects in materials and workmanship, under normal use and service for twelve (12) years to the original purchaser.
- Under this warranty, the manufacturer guarantees the performance of non-polyethylene parts and components on Triple S machines to be free from defects for up to one (1) year to the original end user. Parts replaced under this warranty are guaranteed for the remainder of the original warranty period.
- Labor charges are covered for one (1) full year from the date of purchase for Triple S products, provided an authorized Triple S service provider is used for repair. No travel coverage is extended for cord electric machines.

Product Exceptions & Exclusions: Battery chargers and all accessories are warranted for one year.

Triple S reserves the right to change the warranty policy without notice.

Manufacturer reserves the right to make changes or improvements to its machine without notice.
Always use genuine Triple S parts for repair.

